

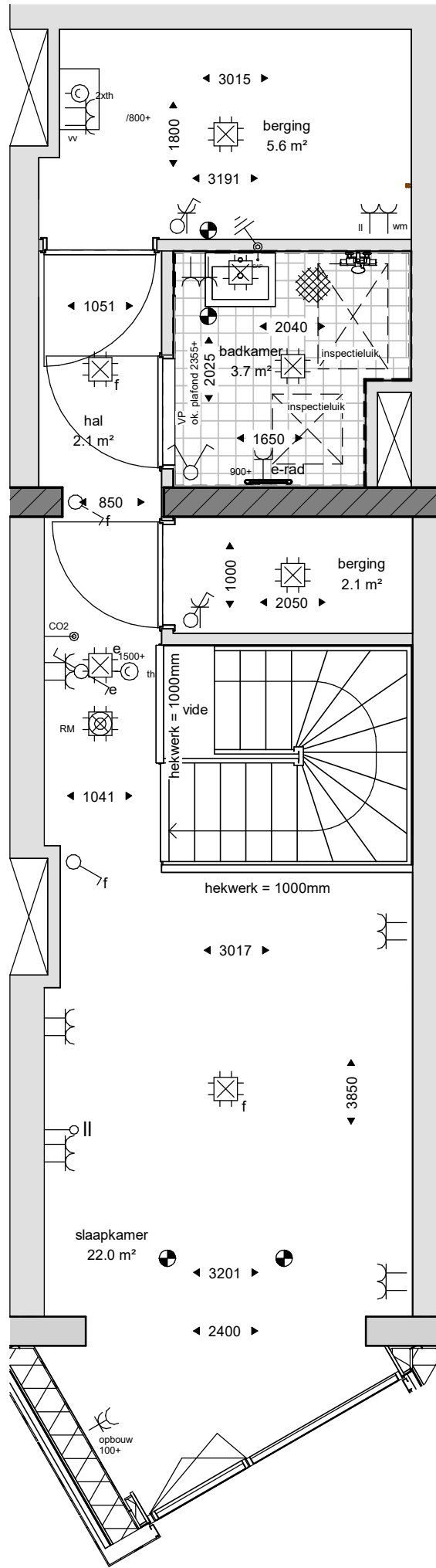

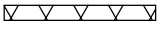

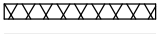













begane grond



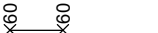
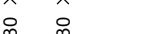

























eerste verdieping

Renvooi bouwkundig

-  minerale wol isolatie
-  pir isolatie
-  in het werk gestort beton
-  cellenbeton
-  geïsoleerde metalstud / houtskeletbouw
-  metalstud / houtskeletbouw
-  geïsoleerde voorzetwand
-  strekmetalen gevelbekleding
-  strekmetalen gevelbekleding
-  wandtegels
-  vloertegels
-  30 Minuten WBDBO
-  60 Minuten WBDBO
-  30 Minuten WBDBO zelfsluitend
-  60 Minuten WBDBO zelfsluitend
-  entree
-  meterkast
-  hemelwaterafvoer
-  kruipluik
-  krijtstreep methode
-  verlaagd plafond

Renvooi installaties

-  plafondlichtpunt
-  armatuur, wandlamp
-  Perilex koken 2x230V 19mm
-  loze leiding
-  enkelpolige schakelaar
-  serieschakelaar (2schak. in 1 inbouwdoos)
-  wisselschakelaar (hotelschakelaar)
-  enkele wandcontactdoos
-  enkele wandcontactdoos e-rad
-  enkele wandcontactdoos afzuigkap
-  enkele wandcontactdoos vaatwasser
-  enkele wandcontactdoos koelkast
-  enkele wandcontactdoos oven
-  dubbele wandcontactdoos
-  dubbele wandcontactdoos tbv. vloerverw. verdeler
-  dubbele wandcontactdoos (half opbouw)
-  enkele wandcontactdoos wasmachine
-  aansluitpunt wandlichtpunt
-  bedrade leiding CO2
-  groepenkast
-  videofoon/ intercom
-  beldrukker
-  thermostaat
-  aarding
-  rookmelder
-  ventilatiepunt (plafond)
-  ventilatiepunt (wand)



Project

Wisselspoor Utrecht

Utrecht

Onderdeel
veld 10

type SKM5a

Bouwnummers: 068

Tekeningnummer
VK(100)170

Datum 12-09-2024 Schaal 1:50 Formaat A1

Fase Verkoop Status Definitief

Architect
Arons & Gelauff Architecten



Aannemer
Van Wijnen

